



PRODUCT CATALOGUE

TRADE LIGHTING SOLUTIONS 2025

Honeywell

CONTENT

Introduction

About Us	04
Our Offices	05
Product Segments	06
Our Ranges	07

Essential Range

LED Lamps

Essential Frosted Lamps	10
Essential Filament Lamps	13
Essential Mini Lamps P45	16

LED Spots

Essential LED Spot MR16	18
Essential LED Spot GU10	21

LED High Lumen Lamp

Essential High Lumen Lamps	24
----------------------------	----

LED Stick

Essential LED Stick Gen. 2	27
----------------------------	----

LED Tube

Essential LED Tube T8	30
-----------------------	----

LED Panel

Essential Backlit Panel	33
Essential Edgelit Panel	36

LED Downlight

Essential SMD Downlight Gen.2	39
Essential COB Downlight	43

CONTENT

LED Floodlight

Essential Floodlight

47

LED High Bay

Essential High Bay

50

LED Weatherproof

Essential LED Weatherproof

53

Essential Weatherproof Housing

57



Honeywell (www.honeywell.com) is a Fortune 100 technology company that delivers industry-specific solutions that include aerospace products and services; control technologies for buildings and industry; and performance materials globally.

Honeywell technologies help everything from aircraft, buildings, manufacturing plants, supply chains, and workers become more connected to make our world smarter, safer, and more sustainable.



WE ARE RETHINKING, REDEFINING AND RENEWING THE LIGHTING INDUSTRY.

VESRA is offering a refreshing dynamism and flexibility, in customer service, in production and in innovation. The quality, efficiency and sustainability the market needs, only much more quickly.

HOW

By continually listening, anticipating, and understanding what our partners and customers are really looking for. Being 100% customer-oriented, putting customer needs first. We never guess. We use our experience, we research, and we test. We add real value and real innovation. Nothing less.

OUR GOAL

To provide the world's best and most sustainable energy saving lighting products that are practical with the highest efficiency and latest technologies. We believe in win-win-win. For our partners, our customers, and our people.

The only way to achieve such an aspirational goal is through teamwork. By working together with talented, dedicated, passionate people, and experts in their field. Yes, we love what we do, but we love people more. After all, the greatest resource is the human resource.

OUR OFFICES



BRANCHES & REPRESENTATIVES

 **USA:**
Trade & Projects: + 1 817 944 7152

 **UAE:**
Trade: + 971 52 349 9579
Projects: + 971 52 131 9641

 **KSA:**
Trade: + 966 55 567 2065
Projects: + 966 55 4444 4727

 **LEVANT:**
Trade & Projects: + 961 76 140 714

 **EGYPT:**
Trade & Projects: + 20 103 337 3335

 **NORTH AFRICA:**
Trade & Projects: + 216 24 844 443

 **CHINA:**
+ 86 138 2515 0228



PRODUCT SEGMENTS

LED LAMPS

Elevate your lighting experience with our brand's cutting-edge LED lamps. Powered by innovative LED technology, these lamps offer superior energy efficiency and an extended lifespan. With instant brilliance and a variety of styles and colors, our LED lamps are perfectly tailored to your lighting needs. Illuminate with confidence, knowing you're reducing your environmental footprint with our state-of-the-art LED lamps.

LED LUMINARIES

Discover the future of lighting with our revolutionary LED luminaries. Powered by cutting-edge LED, these luminaries transcend traditional illumination. Unparalleled energy efficiency and exceptional longevity redefine what lighting can be. Explore an array of styles and colors that cater to your unique preferences, elevating your space with personalized radiance.



OUR RANGES

Our products are available in 3 ranges: Essential, our affordable option, Advanced which offers enhanced features and a prestigious experience, and Ultimate, our range of products with the most advanced features, superior quality, and premium experience.

ESSENTIAL

Typically offers the bare minimum features and functionalities at a low price point. The Essential range is aimed at budget-conscious customers who are looking for an affordable option that meets their basic needs.

ADVANCED

More features and functionalities than the Essential range, at a higher price point. The Advanced range is aimed at customers who are willing to pay extra for enhanced features, better quality, and a more prestigious experience.

ULTIMATE

The highest tier of products, offers the most advanced features, superior quality, and a premium experience at a higher price point. The Ultimate range is aimed at customers who are willing to pay top dollar for the best products available.

WHY CHOOSE?



VALUE FOR MONEY

Our products stand out with brilliant light quality, providing exceptional clarity and color rendering to enhance visibility and create the perfect ambiance. Experience lighting that not only illuminates but also elevates your spaces.



LONGEVITY & DURABILITY

Elevate your lighting experience with our exceptional lifetime options, reaching up to an impressive 50,000 hours, offering unmatched longevity and durability. Enjoy uninterrupted brilliance, knowing that our products are built to last and provide enduring illumination for your needs.



BRILLIANT LIGHT QUALITY

Experience brilliant lighting while saving energy with our products. Achieve efficiency and sustainability with lighting options that not only illuminate beautifully but also contribute to reduced energy consumption, ensuring a brighter future for both your spaces and the environment.

ESSENTIAL RANGE

FROSTED LAMPS



PAGE 10

FILAMENT LAMPS



PAGE 13

LED MINI LAMPS P45



PAGE 16

LED STICK MR16



PAGE 18

LED SPOT GU10



PAGE 21

HIGH LUMEN LAMPS



PAGE 24

LED STICK GEN. 2



PAGE 27

LED TUBE T8



PAGE 30

BACKLIT PANEL



PAGE 33

EDGELIT PANEL



PAGE 36

SMD DOWNLIGHT GEN. 2



PAGE 39

COB DOWNLIGHT

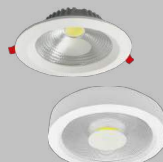

PAGE 43

FLOODLIGHT



PAGE 47

HIGH BAY



PAGE 50

LED WEATHERPROOF



PAGE 53

WEATHERPROOF HOUSING



PAGE 57





ESSENTIAL FROSTED LAMPS



Introducing our Essential LED Frosted Lamps that are energy-efficient lighting solution offering a long lifespan and reduced power consumption compared to traditional lamps.

APPLICATION AREAS

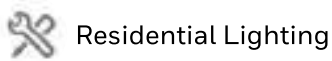

Residential Lighting



Commercial Lighting

FEATURES

- Illuminate with stunning efficiency, thanks to our products luminous efficacy of up to **100 lm/W**
- Enjoy extended operational life with an impressive lifetime of **15,000 hours (L70/B50)** with **2 years of warranty**, reducing the need for frequent lamp replacements
- Effortlessly customize your ambiance with three color temperature options: **3000K, 4000K and 6500K**
- Robust build to withstand shocks and vibrations for long-lasting performance
- Omni-Directional Lighting: Emits light in all directions, ensuring even and uniform illumination
- Experience hassle-free compatibility with our lighting, supporting nominal voltage range of **220-240V** and an operating frequency of **50/60Hz**
- Available with different cap options: **E27** and **E14** bases, catering to different socket types
- Environmentally Friendly: Contains no harmful substances like mercury, making it safe for the environment

TECHNICAL SPECIFICATIONS

MODEL NUMBER	ITEM DESCRIPTION	RATED POWER	RATED LUMENS	RATED CCT	CAP	SHAPE	RATED EFFICACY	LIFETIME	CRI	PF		
841930050311	Ess Bulb 5W 3000K A60 220-240V E27 IP20 ND	5 W	500 LM	3000 K	E27	A60	100 LM/W	15000 HRS	RA>80	>0.5		
841940050321	Ess Bulb 5W 4000K A60 220-240V E27 IP20 ND	5 W	500 LM	4000 K								
841965050331	Ess Bulb 5W 6500K A60 220-240V E27 IP20 ND	5 W	500 LM	6500 K								
841930050191	Ess Bulb 7W 3000K A60 220-240V E27 IP20 ND	7 W	700 LM	3000 K								
841940050201	Ess Bulb 7W 4000K A60 220-240V E27 IP20 ND	7 W	700 LM	4000 K								
841965050211	Ess Bulb 7W 6500K A60 220-240V E27 IP20 ND	7 W	700 LM	6500 K								
841930050221	Ess Bulb 9W 3000K A60 220-240V E27 IP20 ND	9 W	900 LM	3000 K								
841940050231	Ess Bulb 9W 4000K A60 220-240V E27 IP20 ND	9 W	900 LM	4000 K								
841965050241	Ess Bulb 9W 6500K A60 220-240V E27 IP20 ND	9 W	900 LM	6500 K								
841930050251	Ess Bulb 12W 3000K A60 220-240V E27 IP20 ND	12 W	1200 LM	3000 K								
841940050261	Ess Bulb 12W 4000K A60 220-240V E27 IP20 ND	12 W	1200 LM	4000 K								
841965050271	Ess Bulb 12W 6500K A60 220-240V E27 IP20 ND	12 W	1200 LM	6500 K								
841930050281	Ess Bulb 17.7 W 3000K A65 220-240V E27 IP20 ND	17.7W	1800 LM	3000 K							A65	101 LM/W
841940050291	Ess Bulb 17.7 W 4000K A65 220-240V E27 IP20 ND	17.7W	1800 LM	4000 K								
841965050301	Ess Bulb 17.7 W 6500K A65 220-240V E27 IP20 ND	17.7W	1800 LM	6500 K								
841930050341	Ess Candle 5W 3000K B35 220-240V E14 IP20 ND	5 W	500 LM	3000 K	E14	B35	100 LM/W					
841940050351	Ess Candle 5W 4000K B35 220-240V E14 IP20 ND	5 W	500 LM	4000 K								
841965050361	Ess Candle 5W 6500K B35 220-240V E14 IP20 ND	5 W	500 LM	6500 K								

PRODUCT SIZE

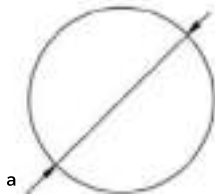
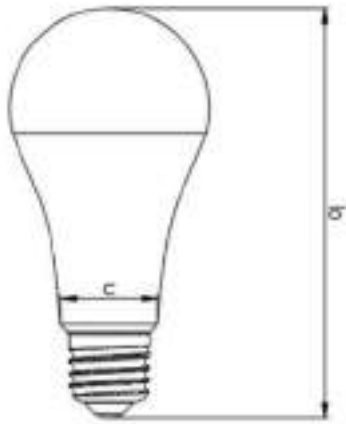

A65 BULB	
a	65MM
b	132MM
c	32.5MM

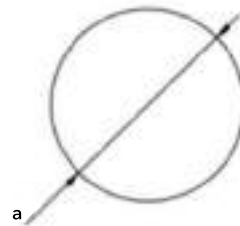
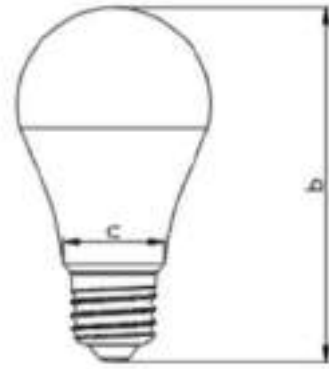

A60 BULB	
a	60MM
b	112MM
c	32.5MM



B35 CANDLE	
a	100MM
b	37MM
c	22MM



ESSENTIAL FILAMENT LAMPS



Introducing our Essential LED Filament Lamps that combine the vintage charm of traditional incandescent bulbs with the energy efficiency and longevity of modern LED technology. Its unique filament design emits a warm and inviting glow, making it an ideal choice for enhancing the ambiance of any space while saving on energy costs.

APPLICATION AREAS

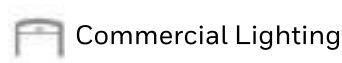
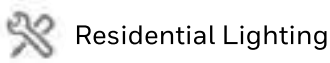

FEATURES

- Vintage filament design that emulates the look of traditional incandescent bulbs, adding a nostalgic touch to any setting
- Illuminate with stunning efficiency, thanks to our products luminous efficacy of up to **120 lm/W**
- Enjoy extended operational life with an impressive lifetime of **15,000 hours (L70/B50)** with **2 years of warranty**, reducing the need for frequent lamp replacements
- Effortlessly customize your ambiance with two color temperature options: **3000K and 6500K**
- Available with different cap options: **E27 and E14** bases, catering to different socket types
- Offering dimming option, allowing you to adjust brightness with a dimmer and set the desired mood
- Omni-Directional Lighting: Emits light in all directions, ensuring even and uniform illumination
- Experience hassle-free compatibility with our lighting, supporting nominal voltage range of **220-240V** and an operating frequency of **50/60Hz**
- Environmentally friendly: Contains no harmful substances like mercury, making it safe for the environment

TECHNICAL SPECIFICATIONS

MODEL NUMBER	ITEM DESCRIPTION	RATED POWER	RATED LUMENS	RATED CCT	CAP	SHAPE	RATED EFFICACY	CRI	PF	DIMMING COMPATIBILITY
841930050111	Ess FIL Bulb 4.2W 3000K A60 220-240V E27 IP20 ND	4.2 W	470 LM	3000 K	E27	A60	112 LM/W	RA>80	>0.5	Non-dimmable
841965050121	Ess FIL Bulb 4.2W 6500K A60 220-240V E27 IP20 ND	4.2 W	470 LM	6500 K		ST64	120 LM/W			Non-dimmable
841930050171	Ess FIL Bulb 5W 3000K ST64 220-240V E27 IP20 ND	5 W	600 LM	3000 K			E14			
841965050181	Ess FIL Bulb 5W 6500K ST64 220-240V E27 IP20 ND	5 W	600 LM	6500 K		E14				B35
841930050151	Ess FIL Candle 5W 3000K B35 220-240V E14 IP20 ND	5 W	500 LM	3000 K	E14		B35	100 LM/W	Non-dimmable	
841965050161	Ess FIL Candle 5W 6500K B35 220-240V E14 IP20 ND	5 W	500 LM	6500 K		E14	B35	100 LM/W		

PRODUCT SIZE

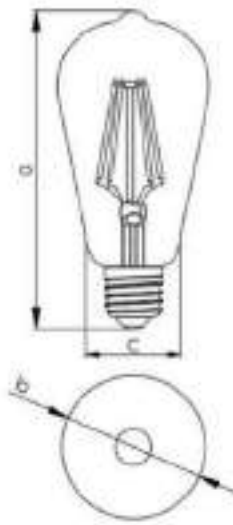

FILAMENT BULB ST64

a	140MM
b	64MM
c	36MM

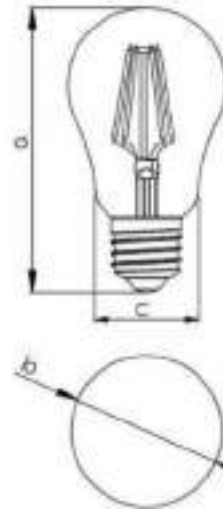

FILAMENT BULB A60

a	106MM
b	60MM
c	33MM

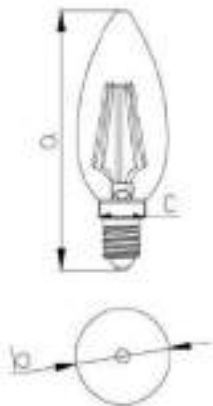

FILAMENT CANDLE B35

a	98MM
b	35MM
c	19MM



ESSENTIAL LED MINI LAMPS P45



Introducing our Essential LED lamps that are energy-efficient lighting solution offers a long lifespan and reduced power consumption compared to traditional lamps

APPLICATION AREAS

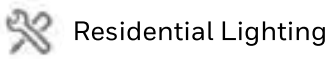

Residential Lighting



Commercial Lighting

FEATURES

- Illuminate with stunning efficiency, thanks to our products luminous efficacy up to 100 lm/W
- Enjoy extended operational life with an impressive lifetime of 15,000 hours (L70/B50), reducing the need for frequent lamp replacements
- Robust build to withstand shocks and vibrations for long-lasting performance.
- Omni-Directional Lighting: Emits light in all directions, ensuring even and uniform illumination.
- Offering dimming option, allowing you to adjust brightness and set the desired mood.
- Experience hassle-free compatibility with our lighting, supporting nominal voltage range of 220-240V and an operating frequency of 50/60Hz
- Robust build to withstand shocks and vibrations for long-lasting performance.
- Environmentally Friendly: Contains no harmful substances like mercury, making it safe for the environment.

TECHNICAL

MODEL NUMBER	ITEM DESCRIPTION	RATED POWER	USEFUL LUMENS	RATED CCT	CAP	SHAPE	RATED EFFICACY	LIFETIME	CRI	PF	DIMMING COMPATIBILITY
841927050381	Ess m bulb 2.9W 2700K P45 220-240V E14 IP20 ND	2.9 W	250 LM	2700 K	E14	P45	86 LM/W	15000 Hrs	RA>80	>0.5	Non-dimmable
841927050391	Ess m bulb 4.9W 2700K P45 220-240V E14 IP20 ND	4.9 W	470 LM	2700 K			96 LM/W				

PRODUCT SIZE

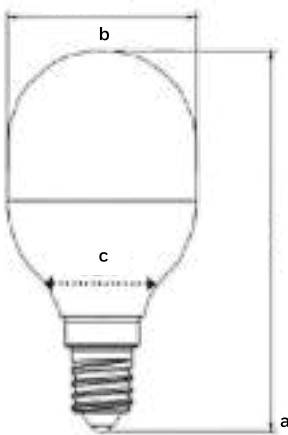

MINI LAMPS P45	2.9W	4.9W
a	79MM	79MM
b	45MM	45MM
c	32.5MM	32.5MM

Essential LED Mini Lamps P45



ESSENTIAL LED SPOT MR16



Introducing our Essential LED Spot MR16 which is a high-quality spotlight, designed to deliver precise and focused lighting. Its compact size and versatile design make it suitable for a wide range of applications. With energy-

efficient LED technology, this spotlight offers great performance and extra cost savings.

APPLICATION AREAS



Residential Lighting



Commercial Lighting

FEATURES

- Versatile design with focused beam that precisely directs light to the target area, providing accurate spotlighting
- Illuminate with stunning efficiency, thanks to our products luminous efficacy of up to **80 lm/W**
- Fits standard **GU5.3 (MR16)** sockets, making it easy to retrofit existing fixtures
- Enjoy extended operational life with an impressive lifetime of **30,000 hours (L70/B50)**, reducing the need for frequent lamp replacements
- Effortlessly customize your ambiance with four color temperature options: **2700K, 3000K, 4000K, and 6500K**
- Experience hassle-free compatibility with our lighting, available in two different operating voltage of **220-240V and 12 V**
- Offering dimming option, allowing you to adjust brightness with a dimmer and set the desired mood
- Environmentally friendly: Contains no harmful substances like mercury, making it safe for the environment

TECHNICAL SPECIFICATIONS

MODEL NUMBER	ITEM DESCRIPTION	RATED POWER	RATED LUMENS	RATED CCT	OPERATING VOLTAGE	RATED EFFICACY	CRI	PF	LIFETIME	WARRANTY	DIMMING COMPATIBILITY
841927090151	Ess Spot MR16 5W 2700K 36D 220-240V GU5.3 IP20 ND	5 W	400 LM	2700 K	220-240 V	80 LM/W	RA>80	>0.5	30,000 HRS	3 years	Non-dimmable
841930090161	Ess Spot MR16 5W 3000K 36D 220-240V GU5.3 IP20 ND	5 W	400 LM	3000 K							
841940090171	Ess Spot MR16 5W 4000K 36D 220-240V GU5.3 IP20 ND	5 W	400 LM	4000 K							
841965090181	Ess Spot MR16 5W 6500K 36D 220-240V GU5.3 IP20 ND	5 W	400 LM	6500 K							

PRODUCT SIZE

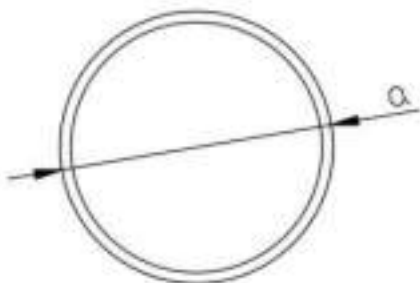
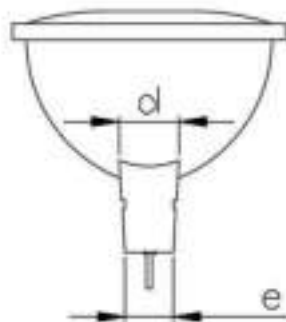
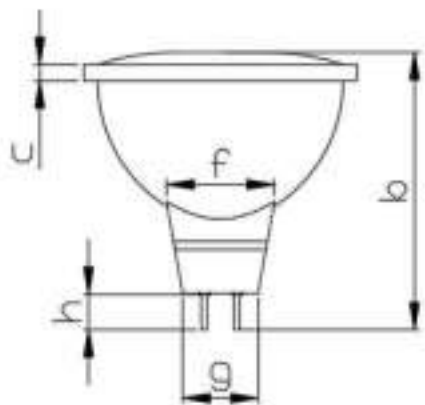

LED SPOT MR16

a	50MM
b	45MM
c	3MM
d	12MM
e	10.5MM
f	19.8MM
g	17MM
h	17MM



ESSENTIAL LED SPOT GU10



Introducing our Essential LED Spot GU10 which is a high-performance spotlight, designed to deliver focused and directional lighting. With its GU10 base,

this LED spot is easy to install and perfect for accentuating specific areas or objects, providing a brilliant and efficient lighting solution.

APPLICATION AREAS



Residential Lighting



Commercial Lighting

FEATURES

- Versatile design with focused beam that precisely directs light to the target area, providing accurate spotlighting
- Illuminate with stunning efficiency, thanks to our products luminous efficacy of up to **80 lm/W**
- Enjoy extended operational life with an impressive lifetime reaches **15,000 hours (L70/B50)**, reducing the need for frequent lamp replacements
- Effortlessly customize your ambiance with four color temperature options: **2700K, 3000K, 4000K and 6500K**
- Robust build to withstand shocks and vibrations for long-lasting performance
- Experience hassle-free compatibility with our lighting, supporting nominal voltage range of **220-240V** and an operating frequency of **50/60Hz**
- Environmentally friendly: Contains no harmful substances like mercury, making it safe for the environment

TECHNICAL SPECIFICATIONS

MODEL NUMBER	ITEM DESCRIPTION	RATED POWER	RATED LUMENS	RATED CCT	RATED EFFICACY	CRI	PF	LIFETIME	WARRANTY	DIMMING COMPATIBILITY
841927090071	Ess Spot GU10 5W 2700K 36D 220-240V GU10 IP20 ND	5 W	400 LM	2700 K	80 LM/W	RA> 80	>0.5	15,000 HRS	2 years	Non-dimmable
841930090081	Ess Spot GU10 5W 3000K 36D 220-240V GU10 IP20 ND	5 W	400 LM	3000 K						
841940090091	Ess Spot GU10 5W 4000K 36D 220-240V GU10 IP20 ND	5 W	400 LM	4000 K						
841965090101	Ess Spot GU10 5W 6500K 36D 220-240V GU10 IP20 ND	5 W	400 LM	6500 K						
841927090221	Ess Spot GU10 7W 2700K 36D 220-240V GU10 IP20 ND	7 W	560 LM	2700 K						
841930090231	Ess Spot GU10 7W 3000K 36D 220-240V GU10 IP20 ND	7 W	560 LM	3000 K						
841940090241	Ess Spot GU10 7W 4000K 36D 220-240V GU10 IP20 ND	7 W	560 LM	4000 K						
841965090251	Ess Spot GU10 7W 6500K 36D 220-240V GU10 IP20 ND	7 W	560 LM	6500 K						

PRODUCT SIZE

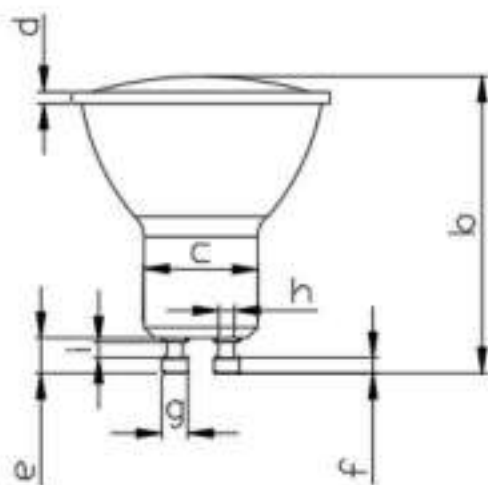

LED SPOT GU10	
a	50MM
b	56MM
c	22MM
d	2.4MM
e	6.5MM
f	3MM
g	3MM
h	3MM
i	3MM



ESSENTIAL HIGH LUMEN LAMPS



Introducing our Essential High Lumen Lamps that offers a safe, reliable, and affordable energy-saving alternative to low-efficiency traditional HID mercury lamp installations. Our high-power lamps not only provide 2x the lifespan of an average HID Mercury lamp, but also come in a classic shape and offer optimized light distribution.

This allows customers to experience a high-quality LED solution for their existing fixtures. Moreover, the robust lamp design with an E27 base ensures easy retrofitting and hassle-free installation.

APPLICATION AREAS



Sidewalk



Warehouses



Gardens

FEATURES

- Illuminate with stunning efficiency, thanks to our products' luminous efficacy of up to **100 lm/w**
- Experience enduring performance with an impressive lifetime of **30,000 hours (L70/B50)** with **3 years of warranty**
- Effortlessly customize your ambiance with three color temperature options: **3000K, 4000K and 6500K**
- Operate seamlessly in temperatures ranging from **-20°C to +40°C** with our meticulously designed lighting
- Experience hassle-free compatibility with our lighting, supporting nominal voltage range of **220-240V** and an operating frequency of **50/60Hz**
- These lamps are energy efficient, contain no lead or mercury, and are compliant with hazardous substances restriction requirements of **RoHS**
- Flicker-free light, providing consistent and stable illumination without any distracting flickering

TECHNICAL SPECIFICATIONS

MODEL NUMBER	ITEM DESCRIPTION	RATED POWER	RATED LUMENS	RATED CCT	RATED EFFICACY	BEAM ANGLE	CRI	PF
841930070011	Ess HLL 25W 3000K 2500 220-240V E27 IP20 ND	25 W	2,500 LM	3000 K	100 LM/W	200 °	RA>80	>0.5
841940070021	Ess HLL 25W 4000K 2500 220-240V E27 IP20 ND	25 W	2,500 LM	4000 K				
841965070031	Ess HLL 25W 6500K 2500 220-240V E27 IP20 ND	25 W	2,500 LM	6500 K				
841930070041	Ess HLL 35W 3000K 3500 220-240V E27 IP20 ND	35 W	3,500 LM	3000 K				>0.9
841940070051	Ess HLL 35W 4000K 3500 220-240V E27 IP20 ND	35 W	3,500 LM	4000 K				
841965070061	Ess HLL 35W 6500K 3500 220-240V E27 IP20 ND	35 W	3,500 LM	6500 K				
841930070071	Ess HLL 42W 3000K 4200 220-240V E27 IP20 ND	42 W	4,200 LM	3000 K				
841940070081	Ess HLL 42W 4000K 4200 220-240V E27 IP20 ND	42 W	4,200 LM	4000 K				
841965070091	Ess HLL 42W 6500K 4200 220-240V E27 IP20 ND	42 W	4,200 LM	6500 K				
841930070611	Ess HLL 55W 3000K 5500 220-240V E27 IP20 ND	55 W	5,500 LM	3000 K				>0.9
841940070621	Ess HLL 55W 4000K 5500 220-240V E27 IP20 ND	55 W	5,500 LM	4000 K				
841965070631	Ess HLL 55W 6500K 5500 220-240V E27 IP20 ND	55 W	5,500 LM	6500 K				

PRODUCT SIZE

ESSENTIAL HIGH LUMEN LAMPS	25W	35W	42W	55W
Diameter	100MM	118M	138MM	160mm/6.3"
Height	168MM	190MM	220mm/8.66"	254mm/10"

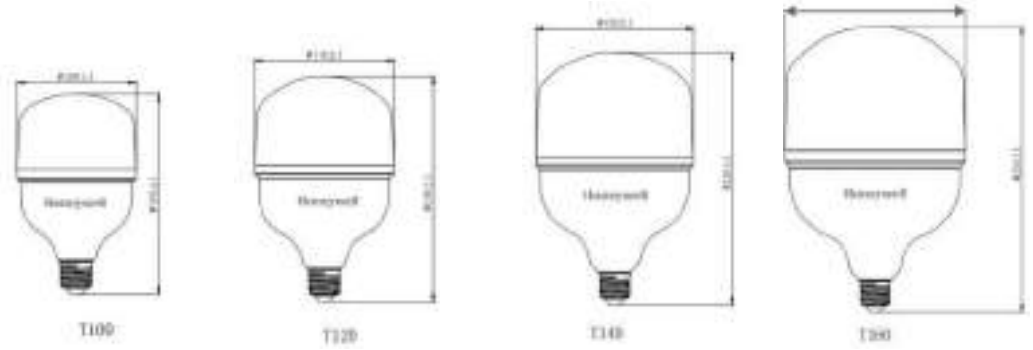



ESSENTIAL LED STICK GEN. 2



Introducing our Essential LED Stick that is a sleek and versatile lighting solution, designed to provide efficient illumination in a compact form factor. With its slim profile and powerful LED technology,

this stick offers a wide range of applications, making it an ideal choice for various needs.

APPLICATION AREAS



Residential Lighting



Commercial Lighting

FEATURES

- Slim and stylish: the Essential LED Stick features a sleek design that seamlessly blends with any decor
- Illuminate with stunning efficiency, thanks to our products luminous efficacy of up to **120 lm/W**
- Enjoy extended operational life with an impressive lifetime of **15,000 hours (L70/B50)** with **2 years of warranty**, reducing the need for frequent lamp replacements
- Effortlessly customize your ambiance with three color temperature options: **3000K, 4000K, and 6500K**
- Omni-Directional Lighting: Emits light in all directions, ensuring even and uniform illumination
- Experience hassle-free compatibility with our lighting, supporting a wide nominal voltage range of **100-240V** and an operating frequency of **50/60Hz**
- Environmentally friendly: Contains no harmful substances like mercury, making it safe for the environment
- Flicker-free, ensuring a stable and comfortable lighting experience without any noticeable flickering or eye strain

TECHNICAL SPECIFICATIONS

MODEL NUMBER	ITEM DESCRIPTION	RATED POWER	RATED LUMENS	RATED CCT	VOLTAGE	RATED EFFICACY	CRI	PF	LIFE SPAN	WARRANTY
84193010201	Ess Stick 7W 3000K T36 100-240V E27 IP20 ND	7 W	840 LM	3000 K	100-240 V	120 LM/W	RA>80	>0.5	15,000 Hrs	2 Years
84194010202	Ess Stick 7W 4000K T36 100-240V E27 IP20 ND	7 W	840 LM	4000 K						
84196510203	Ess Stick 7W 6500K T36 100-240V E27 IP20 ND	7 W	840 LM	6500 K						
84193010204	Ess Stick 9W 3000K T36 100-240V E27 IP20 ND	9 W	1080 LM	3000 K						
84194010205	Ess Stick 9W 4000K T36 100-240V E27 IP20 ND	9 W	1080 LM	4000 K						
84196510206	Ess Stick 9W 6500K T36 100-240V E27 IP20 ND	9 W	1080 LM	6500 K						
84193010207	Ess Stick 10W 3000K T36 100-240V E27 IP20 ND	10 W	1200 LM	3000 K						
84194010208	Ess Stick 10W 4000K T36 100-240V E27 IP20 ND	10 W	1200 LM	4000 K						
84196510209	Ess Stick 10W 6500K T36 100-240V E27 IP20 ND	10 W	1200 LM	6500 K						
84193010210	Ess Stick 12W 3000K T44 100-240V E27 IP20 ND	12 W	1440 LM	3000 K						
84194010211	Ess Stick 12W 4000K T44 100-240V E27 IP20 ND	12 W	1440 LM	4000 K						
84196510212	Ess Stick 12W 6500K T44 100-240V E27 IP20 ND	12 W	1440 LM	6500 K						
84193010213	Ess Stick 14W 3000K T48 100-240V E27 IP20 ND	14 W	1680 LM	3000 K						
84194010214	Ess Stick 14W 4000K T48 100-240V E27 IP20 ND	14 W	1680 LM	4000 K						
84196510215	Ess Stick 14W 6500K T48 100-240V E27 IP20 ND	14 W	1680 LM	6500 K						

Note: Check with your local sales organization for ordering codes

PRODUCT SIZE

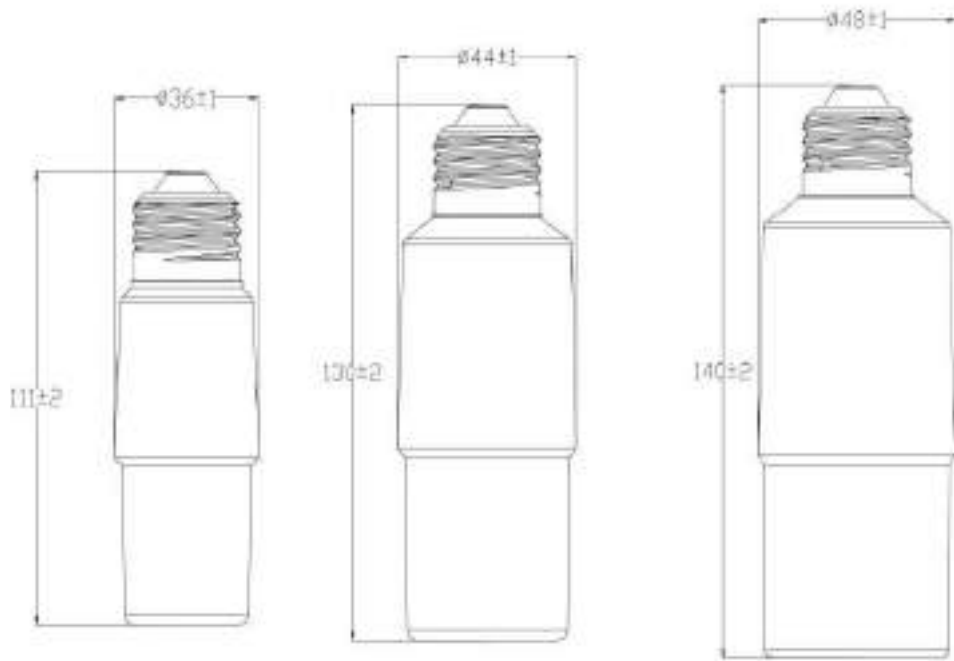

ESSENTIAL LED STICK	7W(E27)	9W(E27)	10W(E27)	12W(E27)	14W(E27)
a	36±1MM	36±1MM	36±1MM	44±1MM	48±1MM
b	111±2MM	111±2MM	111±2MM	130±2MM	140±2MM



ESSENTIAL LED TUBE T8



Introducing our Essential LED Tube T8 which offers a highly efficient and versatile lighting solution, designed to replace traditional fluorescent tubes. With its optimized light distribution, various size and color

temperature options, and easy installation, it is an ideal choice for commercial, industrial, and residential spaces, providing cost-effective and eco-friendly lighting performance.

APPLICATION AREAS

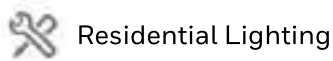

Residential Lighting



Commercial Lighting



Educational
Institutions

FEATURES

- Illuminate with stunning efficiency, thanks to our products luminous efficacy of 120 lm/W
- Experience enduring performance with an impressive lifetime of 25,000 hours (L70/B50) with 3 years of warranty
- Effortlessly customize your ambiance with four color temperature options: 3000K, 4000K, 6500K, and 8000K
- Operate seamlessly in temperatures ranging from -20°C to +45°C with our meticulously designed lighting
- Various size options including 2 feet, 4 feet, and 5 feet, making them compatible with most standard fluorescent fixtures
- Designed for easy installation, offers plug-and-play compatibility, allowing direct replacement of existing fluorescent tubes
- Offers both single-ended and double-ended connection options, providing flexibility in installation methods based on specific fixture requirements
- Instant startup without any warm-up time, ensuring immediate and consistent illumination
- Flicker-free, ensuring a stable and comfortable lighting experience without any noticeable flickering or eye strain
- Offer uniform and consistent light distribution, eliminating dark spots and providing even illumination throughout the space

TECHNICAL SPECIFICATIONS

MODEL NUMBER	ITEM DESCRIPTION	CONNECTION	RATED POWER	RATED LUMENS	RATED CCT	OPERATING VOLTAGE	RATED EFFICACY	CRI	PF
841930110011	Ess DE TLED T8 9W 3000K 60cm 220-240V G13 IP20 ND	Double Ended	9 W	1080 LM	3000 K	220-240 V	120 LM/W	RA>80	>0.5
841940110021	Ess DE TLED T8 9W 4000K 60cm 220-240V G13 IP20 ND		9 W	1080 LM	4000 K				
841965110031	Ess DE TLED T8 9W 6500K 60cm 220-240V G13 IP20 ND		9 W	1080 LM	6500 K				
841980110041	Ess DE TLED T8 9W 8000K 60cm 220-240V G13 IP20 ND		9 W	1080 LM	8000 K				
841930110051	Ess DE TLED T8 18W 3000K 120cm 220-240V G13 IP20 ND		18 W	2160 LM	3000 K				
841940110061	Ess DE TLED T8 18W 4000K 120cm 220-240V G13 IP20 ND		18 W	2160 LM	4000 K				
841965110071	Ess DE TLED T8 18W 6500K 120cm 220-240V G13 IP20 ND		18 W	2160 LM	6500 K				
841980110081	Ess DE TLED T8 18W 8000K 120cm 220-240V G13 IP20 ND		18 W	2160 LM	8000 K				
841930110091	Ess DE TLED T8 25W 3000K 120cm 220-240V G13 IP20 ND		25 W	3000 LM	3000 K				
841940110101	Ess DE TLED T8 25W 4000K 150cm 220-240V G13 IP20 ND		25 W	3000 LM	4000 K				
841965110111	Ess DE TLED T8 25W 6500K 150cm 220-240V G13 IP20 ND		25 W	3000 LM	6500 K				
841980110121	Ess DE TLED T8 25W 8000K 150cm 220-240V G13 IP20 ND		25 W	3000 LM	8000 K				
841930110131	Ess SE TLED T8 9W 3000K 60cm 100-240V G13 IP20 ND	Single Ended	9 W	1080 LM	3000 K	100-240 V	120 LM/W	RA>80	>0.5
841940110141	Ess SE TLED T8 9W 4000K 60cm 100-240V G13 IP20 ND		9 W	1080 LM	4000 K				
841965110151	Ess SE TLED T8 9W 6500K 60cm 100-240V G13 IP20 ND		9 W	1080 LM	6500 K				
841930110161	Ess SE TLED T8 18W 3000K 120cm 100-240V G13 IP20 ND		18 W	2160 LM	3000 K				
841940110171	Ess SE TLED T8 18W 4000K 120cm 100-240V G13 IP20 ND		18 W	2160 LM	4000 K				
841965110181	Ess SE TLED T8 18W 6500K 120cm 100-240V G13 IP20 ND		18 W	2160 LM	6500 K				
841930110191	Ess SE TLED T8 24W 3000K 150cm 100-240V G13 IP20 ND		24 W	2880 LM	3000 K				
841940110201	Ess SE TLED T8 24W 4000K 150cm 100-240V G13 IP20 ND		24 W	2880 LM	4000 K				
841965110211	Ess SE TLED T8 24W 6500K 150cm 100-240V G13 IP20 ND		24 W	2880 LM	6500 K				

PRODUCT SIZE

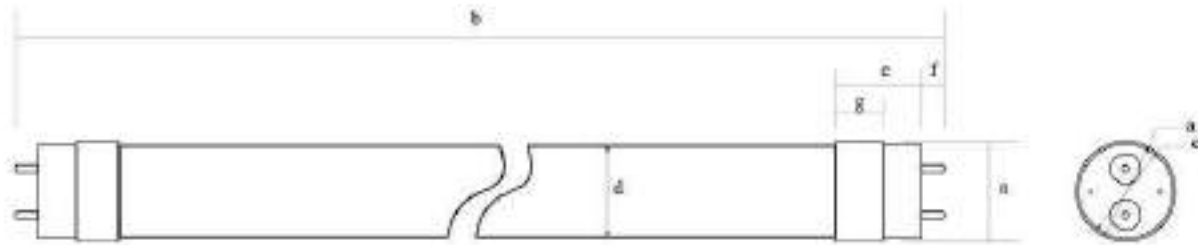

ESSENTIAL LED TUBE T8	9 W	18 W	24 W & 25 W
a	28MM	28MM	28MM
b	605MM	1213MM	1513MM
c	25.2MM	25.2MM	25.2MM
d	25.4MM	25.4MM	25.4MM
e	40MM	40MM	40MM
f	7MM	7MM	7MM
g	30MM	30MM	30MM



ESSENTIAL BACKLIT PANEL



Introducing our Essential LED panel with backlit technology that is an energy-efficient and sleek lighting solution designed to fit standard 60X60cm grid ceilings. With uniform and With uniform illumination, it creates a comfortable working

environment in offices, retail, and commercial spaces with easy installation and flicker-free technology make it a hassle-free upgrade for existing fixtures, providing both aesthetics and efficiency in commercial settings.

APPLICATION AREAS

 Residential Lighting

 Commercial Lighting

 Educational Institutions

FEATURES

- Illuminate with stunning efficiency, thanks to our products luminous efficacy up to 100 lm/W
- Effortlessly customize your ambiance with two color temperature options: 4000K and 6500K
- Operate seamlessly in temperatures ranging from -20°C to +45°C with our meticulously designed lighting
- Provides uniform and even illumination across the entire surface, creating a comfortable and well-lit environment
- Designed for easy installation and compatibility with standard 60*60cm grid ceilings, making it a hassle-free upgrade for existing lighting fixtures
- Instant start-up without any warm-up time, ensuring immediate and consistent illumination
- Flicker-free, ensuring a stable and comfortable lighting experience without any noticeable flickering or eye strain
- Enhances the ambiance and visual appeal of commercial spaces with its modern and sophisticated design

TECHNICAL SPECIFICATIONS

MODEL NUMBER	ITEM DESCRIPTION	RATED POWER	USEFUL LUMENS	RATED CCT	RATED EFFICACY	LIFESPAN L70	WARRANTY	OPERATING VOLTAGE	CRI	DF
841940120012	Ess BL 40W 4000K 4000 220-240V 60X60 IP20 ND	40 W	4000 LM	4000 K	100 LM/W	50,000 HRS	5 Years	220-240 V	RA>80	>0.9
841965120022	Ess BL 40W 6500K 4000 220-240V 60X60 IP20 ND	40 W	4000 LM	6500 K						
841940120052	Ess BL 50W 4000K 5000 220-240V 60X60 IP20 ND	50 W	5000 LM	4000 K						
841965120062	Ess BL 50W 6500K 5000 220-240V 60X60 IP20 ND	50 W	5000 LM	6500 K						

POLAR INTENSITY DIAGRAM

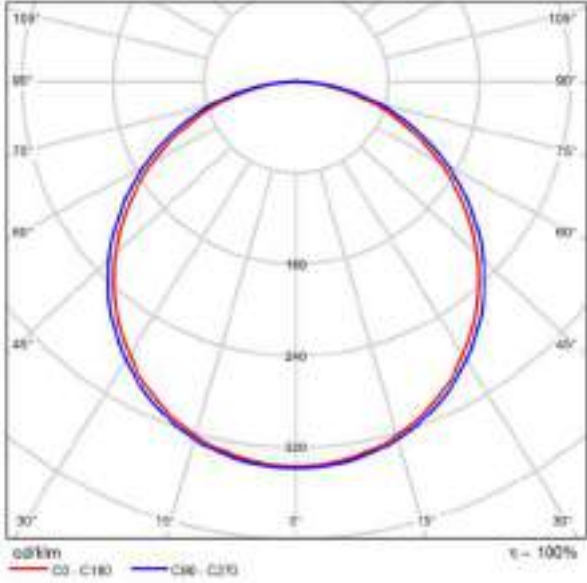

PRODUCT SIZE

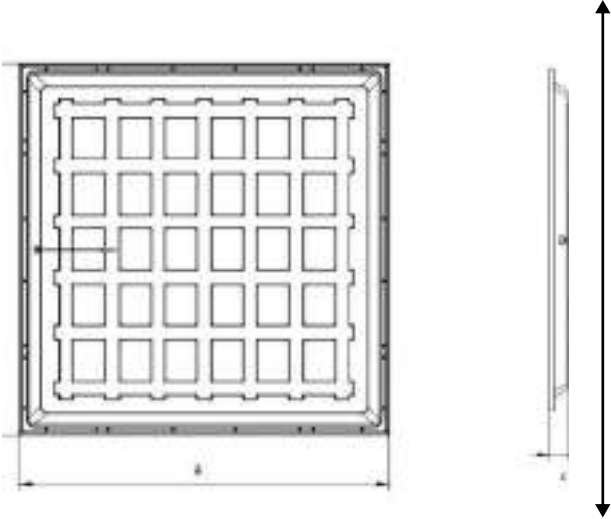

ESSENTIAL LED PANEL	40W	50W
a	595MM	595MM
b	595MM	595MM
c	30MM	30MM



ESSENTIAL EDGE LIT PANEL



Introducing our Essential LED panel with Edgelit technology that is an energy-efficient and sleek lighting solution designed to fit standard 60X60cm grid ceilings. With uniform illumination, it creates a comfortable working

environment in offices, retail, and commercial spaces with easy installation and flicker-free technology make it a hassle-free upgrade for existing fixtures, providing both aesthetics and efficiency in commercial settings.

APPLICATION AREAS



Residential Lighting



Commercial Lighting



Educational
Institutions

FEATURES

- Ultra thin sleek design, and higher efficacy compared to traditional panels
- Illuminate with stunning efficiency, thanks to our products luminous efficacy up to 120 lm/W
- Effortlessly customize your ambiance with two color temperature options: 4000K and 6500K
- Operate seamlessly in temperatures ranging from -20°C to +45°C with our meticulously designed lighting
- Provides uniform and even illumination across the entire surface, creating a comfortable and well-lit environment
- Designed for easy installation and compatibility with standard 60*60cm grid ceilings, making it a hassle-free upgrade for existing lighting fixtures
- Instant start-up without any warm-up time, ensuring immediate and consistent illumination
- Flicker-free, ensuring a stable and comfortable lighting experience without any noticeable flickering or eye strain
- Enhances the ambiance and visual appeal of commercial spaces with its modern and sophisticated design

TECHNICAL SPECIFICATIONS

MODEL NUMBER	ITEM DESCRIPTION	RATED POWER	USEFUL LUMENS	RATED CCT	RATED EFFICACY	LIFESPAN L70	OPERATING VOLTAGE	CRI	DF
841940120032	Ess EL 35W 4000K 4200 100-240V 60X60 IP20 ND	35W	4200 LM	4000 K	120 LM/W	50,000 HRS	100-240 V	RA>80	>0.9
841965120042	Ess EL 35W 6500K 4200 100-240V 60X60 IP20 ND	35 W	4200 LM	6500 K	120 LM/W	50,000 HRS			

PRODUCT SIZE

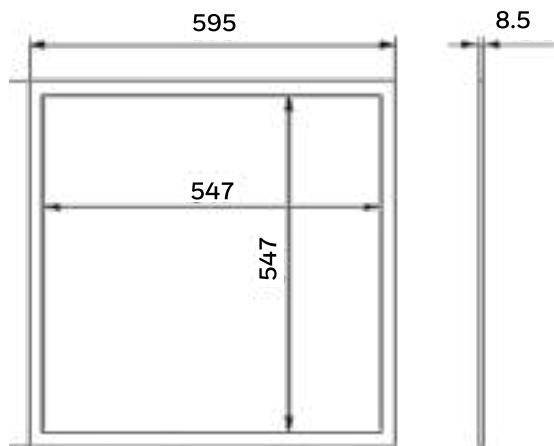

ESSENTIAL LED PANEL		35W
a	595MM	
b	595MM	
c	8.5MM	

POLAR INTENSITY DIAGRAM

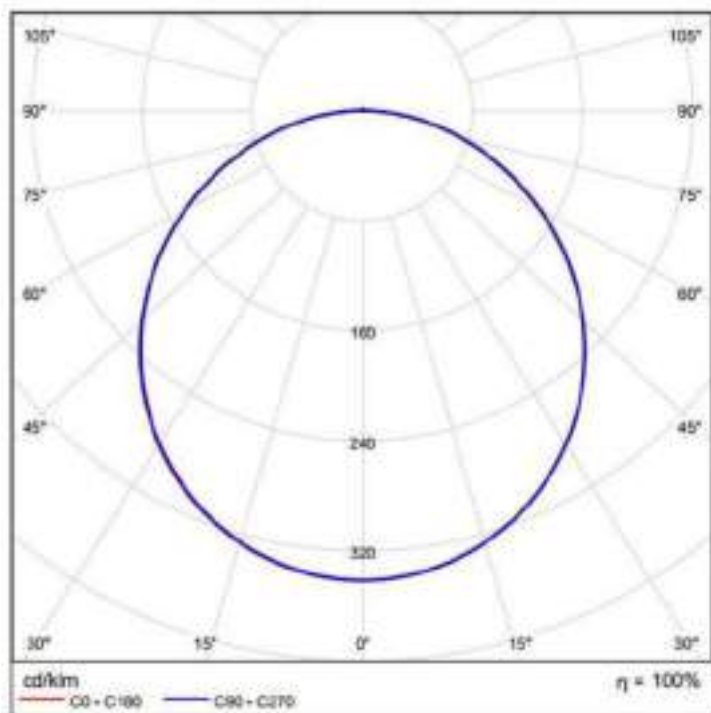



ESSENTIAL SMD DOWNLIGHT GEN. 2



Introducing our Essential SMD Downlight series which offers a versatile and energy-efficient lighting solution, available in both round and square shapes. Designed for seamless integration into various indoor environments. These downlights are suitable for both recessed and surface-mounted installations, these fixtures deliver exceptional lighting performance while maintaining a sleek and modern aesthetic.

APPLICATION AREAS

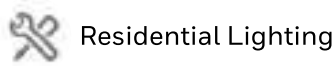

Residential Lighting



Commercial Lighting

FEATURES

- Choose between classic round and modern square shapes, allowing seamless integration into diverse architectural designs
- Illuminate with stunning efficiency, thanks to our products luminous efficacy up to 90 lm/W with displacement factor > 0.7
- Experience enduring performance with an impressive lifetime of 25,000 hours (L70/B50) with 3 years of warranty
- Effortlessly customize your ambiance with three color temperature options: 3000K, 4000K, and 6500K
- Our Comprehensive range includes specialized products for recessed or surface-mounted installation, available in various cutouts and sizes that allows you to select the perfect fit for your space, ensuring seamless integration and optimal lighting performance
- Experience hassle-free compatibility with our lighting, supporting nominal voltage range of 220–240V and an operating frequency of 50/60Hz
- Designed for hassle-free installation, compatible with standard wiring systems
- Flicker-free, ensuring a stable and comfortable lighting experience without any noticeable flickering or eye strain
- Offer uniform and consistent light distribution, eliminating dark spots and providing even illumination throughout the space
- These fixtures are energy efficient, contain no lead or mercury, and are compliant with hazardous substances restriction requirements of RoHS
- Offered in both IP20 and IP44 versions, our LED downlights are designed to meet diverse needs, providing flexibility for various applications while ensuring reliable performance and protection

PRODUCT SIZE

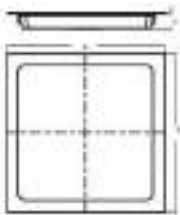

SQUARE RECESSED	9W	12W	18W	24W
a	25.5MM	25.5MM	28.5MM	28.5MM
b	145MM	175MM	223MM	298MM

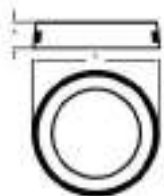

ROUND SURFACE	12W	18W	24W
a	32 MM	32 MM	32 MM
b	168 MM	223 MM	298 MM

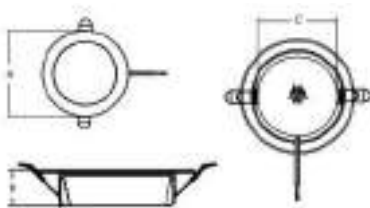

ROUND RECESSED	5W	9W	18W	23W
a	100MM	130MM	175MM	220MM
b	33±2MM	35±2MM	35±2MM	35±2MM
c	51MM	101MM	124MM	168MM

POLAR INTENSITY DIAGRAM

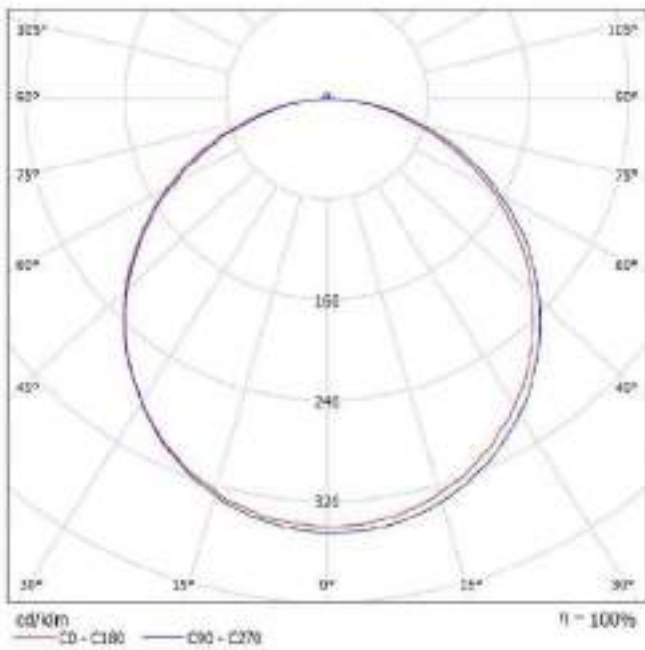

Recessed mount round

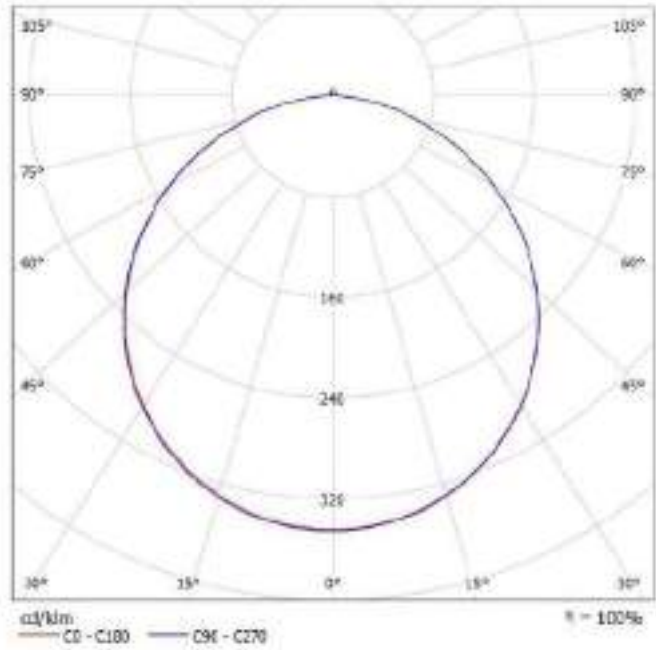

Recessed mount square

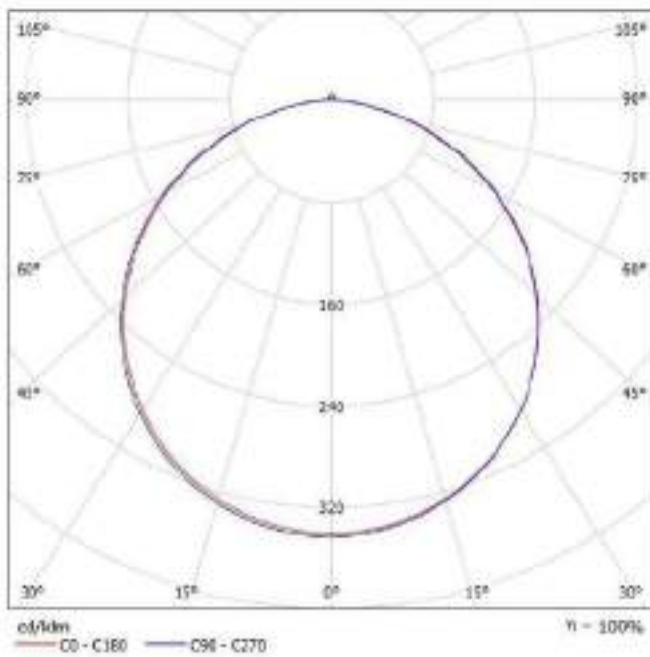

Surface mount round

TECHNICAL SPECIFICATIONS

MODEL NUMBER	ITEM DESCRIPTION	MOUNTING TYPE	PRODUCT SHAPE	RATED POWER	RATED LUMENS	RATED EFFICACY	RATED CCT	CUTOUT SIZE				
84193003301	Ess R SMD DL 5W 3000K 3 Inch 220-240V 75±5 IP20 ND	Recessed	Round	5 W	386 LM	77 LM/W	3000 K	75±5 mm				
84194003302	Ess R SMD DL 5W 4000K 3 Inch 220-240V 75±5 IP20 ND			5 W	400 LM	80 LM/W	4000 K					
84196503303	Ess R SMD DL 5W 6500K 3 Inch 220-240V 75±5 IP20 ND			5 W	400 LM	80 LM/W	6500 K					
84193003304	Ess R SMD DL 9W 3000K 4 Inch 220-240V 100±5 IP20 ND			Recessed	Round	9 W	745 LM	83 LM/W	3000 K	100±5 mm		
84194003305	Ess R SMD DL 9W 4000K 4 Inch 220-240V 100±5 IP20 ND					9 W	810 LM	90 LM/W	4000 K			
84196503306	Ess R SMD DL 9W 6500K 4 Inch 220-240V 100±5 IP20 ND					9 W	810 LM	90 LM/W	6500 K			
84193003307	Ess R SMD DL 18W 3000K 6 Inch 220-240V 140±5 IP20 ND					Recessed	Round	18 W	1441 LM	80 LM/W	3000 K	140±5 mm
84194003308	Ess R SMD DL 18W 4000K 6 Inch 220-240V 140±5 IP20 ND							18 W	1566 LM	85 LM/W	4000 K	
84196503309	Ess R SMD DL 18W 6500K 6 Inch 220-240V 140±5 IP20 ND							18 W	1566 LM	85 LM/W	6500 K	
84193003310	Ess R SMD DL 23W 3000K 8 Inch 220-240V 190±5 IP20 ND			Recessed	Round	23 W	1904 LM	83 LM/W	3000 K	190±5 mm		
84194003311	Ess R SMD DL 23W 4000K 8 Inch 220-240V 190±5 IP20 ND					23 W	2070 LM	90 LM/W	4000 K			
84196503312	Ess R SMD DL 23W 6500K 8 Inch 220-240V 190±5 IP20 ND					23 W	2070 LM	90 LM/W	6500 K			
84193003313	Ess Surface R SMD DL 12W 3000K 220-240V IP20 ND	Surface Mounted	Round	12 W	883 LM	74 LM/W	3000 K	NA				
84194003314	Ess Surface R SMD DL 12W 4000K 220-240V IP20 ND			12 W	960 LM	80 LM/W	4000 K					
84196503315	Ess Surface R SMD DL 12W 6500K 220-240V IP20 ND			12 W	960 LM	80 LM/W	6500 K					
84193003316	Ess Surface R SMD DL 18W 3000K 220-240V IP20 ND			18 W	1325 LM	74 LM/W	3000 K					
84194003317	Ess Surface R SMD DL 18W 4000K 220-240V IP20 ND			18 W	1440 LM	80 LM/W	4000 K					
84196503318	Ess Surface R SMD DL 18W 6500K 220-240V IP20 ND			18 W	1440 LM	80 LM/W	6500 K					
84193003319	Ess Surface R SMD DL 24W 3000K 220-240V IP20 ND			24 W	1766 LM	74 LM/W	3000 K					
84194003320	Ess Surface R SMD DL 24W 4000K 220-240V IP20 ND			24 W	1920 LM	80 LM/W	4000 K					
84196503321	Ess Surface R SMD DL 24W 6500K 220-240V IP20 ND			24 W	1920 LM	80 LM/W	6500 K					
84193003322	Ess SQ SMD DL 9W 3000K 220-240V 115x115 IP20 ND			Recessed	Square	9 W	745 LM		83 LM/W	3000 K	115x115 mm	
84194003323	Ess SQ SMD DL 9W 4000K 220-240V 115x115 IP20 ND	9 W	810 LM			90 LM/W	4000 K					
84196503324	Ess SQ SMD DL 9W 6500K 220-240V 115x115 IP20 ND	9 W	810 LM			90 LM/W	6500 K					
84193003325	Ess SQ SMD DL 12W 3000K 220-240V 145x145 IP20 ND	Recessed	Square			12 W	994 LM	83 LM/W	3000 K	145x145 mm		
84194003326	Ess SQ SMD DL 12W 4000K 220-240V 145x145 IP20 ND					12 W	1080 LM	90 LM/W	4000 K			
84196503327	Ess SQ SMD DL 12W 6500K 220-240V 145x145 IP20 ND					12 W	1080 LM	90 LM/W	6500 K			
84193003328	Ess SQ SMD DL 18W 3000K 220-240V 190x190 IP20 ND					Recessed	Square	18 W	1423 LM	83 LM/W	3000 K	190x190 mm
84194003329	Ess SQ SMD DL 18W 4000K 220-240V 190x190 IP20 ND							18 W	1530 LM	90 LM/W	4000 K	
84196503330	Ess SQ SMD DL 18W 6500K 220-240V 190x190 IP20 ND							18 W	1530 LM	90 LM/W	6500 K	
84193003331	Ess SQ SMD DL 24W 3000K 220-240V 258x258 IP20 ND	Recessed	Square			24 W	1987 LM	83 LM/W	3000 K	258x258 mm		
84194003332	Ess SQ SMD DL 24W 4000K 220-240V 258x258 IP20 ND					24 W	2160 LM	90 LM/W	4000 K			
84196503333	Ess SQ SMD DL 24W 6500K 220-240V 258x258 IP20 ND					24 W	2160 LM	90 LM/W	6500 K			

Note: Check with your local sales organization for ordering codes



ESSENTIAL COB DOWNLIGHT



Introducing our COB Downlight family featuring a compact design that makes installation a breeze, seamlessly fitting into standard ceilings fixtures and offering exceptional energy savings compared to traditional lighting. This makes it an ideal sustainable choice for both residential and commercial settings, with durability as its core, ensuring a long lifespan of consistent, high-performance lighting. Whether it's offices, or retail spaces, our COB Downlight guarantees an upgrade in functionality and style.

APPLICATION AREAS



Residential Lighting



Commercial Lighting

FEATURES

- Illuminate with stunning efficiency, thanks to our products luminous efficacy up to 90 lm/W
- Experience enduring performance with an impressive lifetime of 30,000 hours (L70/B50) with 3 years warranty
- Effortlessly customize your ambiance with three color temperature options: 3000K, 4000K and 6500K
- Experience hassle-free compatibility with our lighting, supporting wide nominal voltage range of 100-240V and an operating frequency of 50/60Hz
- Comprehensive range includes specialized products for recessed or surface-mounted installation, available in various cutouts and sizes that allows you to select the perfect fit for your space, ensuring seamless integration and optimal lighting performance
- Operate seamlessly in temperatures ranging from -20°C to +40°C with our meticulously designed lighting
- Designed for hassle-free installation, compatible with standard wiring systems
- Offer uniform and consistent light distribution, eliminating dark spots and providing even illumination throughout the space
- These fixtures are energy efficient, contain no lead or mercury, and are compliant with hazardous substances restriction requirements of RoHS

TECHNICAL SPECIFICATIONS

MODEL NUMBER	ITEM DESCRIPTION	RATED POWER	LUMINOUS FLUX	RATED CCT	MOUNTING TYPE	OPERATING VOLTAGE	CRI	DF	
841930020342	Ess COB DL 7W 3000K 3 Inch 100-240V 7.5cm IP20 ND	7 W	630 LM	3000 K	Recessed Mounted	100-240 V	> 80	> 0.7	
841940020352	Ess COB DL 7W 4000K 3 Inch 100-240V 7.5cm IP20 ND	7 W	630 LM	4000 K					
841965020362	Ess COB DL 7W 6500K 3 Inch 100-240V 7.5cm IP20 ND	7 W	630 LM	6500 K					
841930020312	Ess COB DL 10W 3000K 4 Inch 100-240V 10.5cm IP20 ND	10 W	900 LM	3000 K					
841940020322	Ess COB DL 10W 4000K 4 Inch 100-240V 10.5cm IP20 ND	10 W	900 LM	4000 K					
841965020332	Ess COB DL 10W 6500K 4 Inch 100-240V 10.5cm IP20 ND	10 W	900 LM	6500 K					
841930020282	Ess COB DL 15W 3000K 6 Inch 100-240V 14cm IP20 ND	15 W	1350 LM	3000 K				Surface Mounted	> 0.9
841940020292	Ess COB DL 15W 4000K 6 Inch 100-240V 14cm IP20 ND	15 W	1350 LM	4000 K					
841965020302	Ess COB DL 15W 6500K 6 Inch 100-240V 14cm IP20 ND	15 W	1350 LM	6500 K					
841930020252	Ess COB DL 30W 3000K 8 Inch 100-240V 20cm IP20 ND	30 W	2700 LM	3000 K					
841940020262	Ess COB DL 30W 4000K 8 Inch 100-240V 20cm IP20 ND	30 W	2700 LM	4000 K					
841965020272	Ess COB DL 30W 6500K 8 Inch 100-240V 20cm IP20 ND	30 W	2700 LM	6500 K					
841930020372	Ess COB Surface DL 20W 3000K 100-240V 16 cm IP20 ND	20 W	1800 LM	3000 K					
841940020382	Ess COB Surface DL 20W 4000K 100-240V 16 cm IP20 ND	20 W	1800 LM	4000 K					
841965020392	Ess COB Surface DL 20W 6500K 100-240V 16 cm IP20 ND	20 W	1800 LM	6500 K					
841930020402	Ess COB Surface DL 30W 3000K 100-240V 22 cm IP20 ND	30 W	2700 LM	3000 K					
841940020412	Ess COB Surface DL 30W 4000K 100-240V 22 cm IP20 ND	30 W	2700 LM	4000 K					
841965020422	Ess COB Surface DL 30W 6500K 100-240V 22 cm IP20 ND	30 W	2700 LM	6500 K					
841930020432	Ess COB Surface DL 40W 3000K 100-240V 30 cm IP20 ND	40 W	3600 LM	3000 K					
841940020442	Ess COB Surface DL 40W 4000K 100-240V 30 cm IP20 ND	40 W	3600 LM	4000 K					
841965020452	Ess COB Surface DL 40W 6500K 100-240V 30 cm IP20 ND	40 W	3600 LM	6500 K					

POLAR INTENSITY DIAGRAM

7W

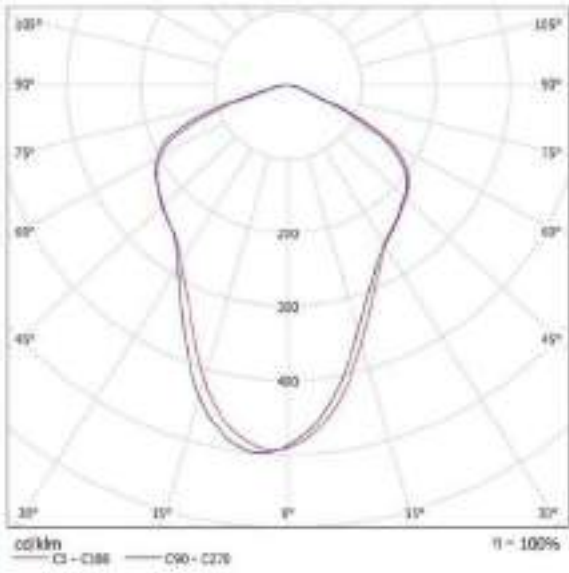

10W

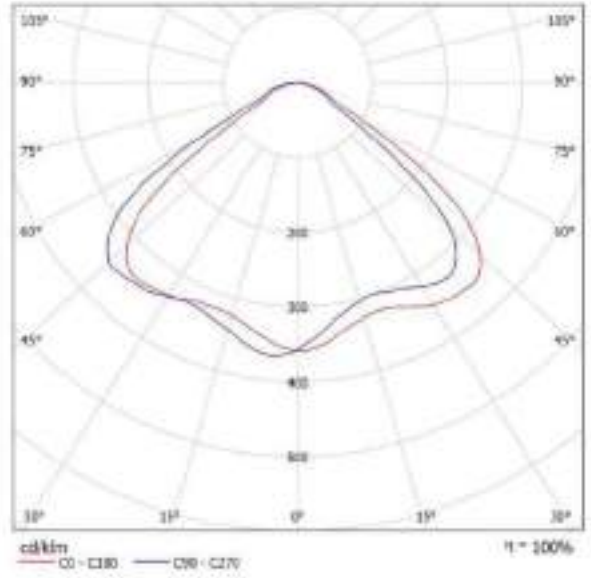

15W

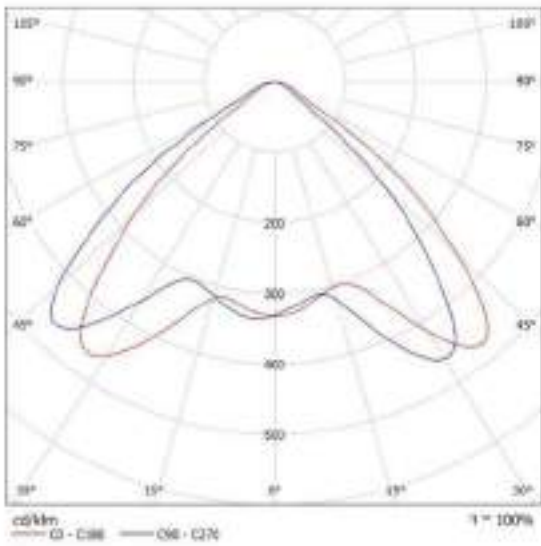

30W

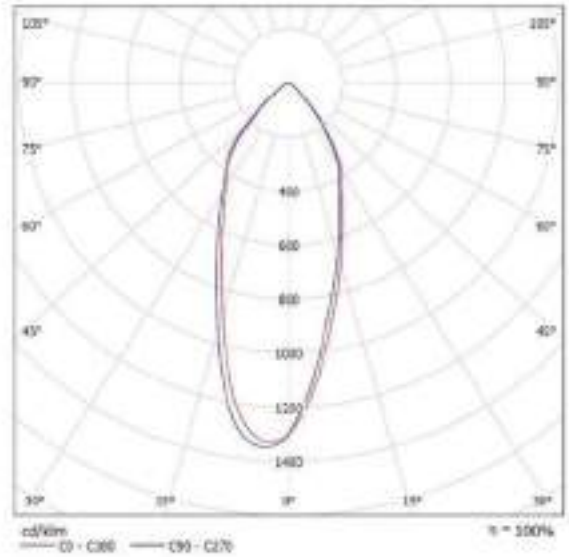

PRODUCT SIZE

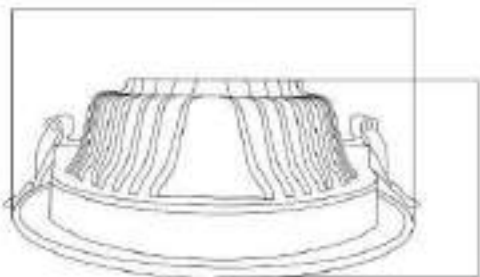

ESSENTIAL COB RECESSED DOWNLIGHT	LENGTH	WIDTH	HEIGHT	CUT OUT
7 W	90MM	90MM	55MM	75MM
10 W	125MM	125MM	55MM	105MM
15 W	160MM	160MM	55MM	140MM
30 W	220MM	220MM	55MM	200MM

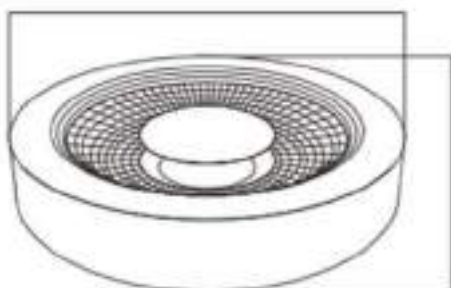

ESSENTIAL COB SURFACE DOWNLIGHT	DIAMETER	HEIGHT
20 W	170MM	38MM
30 W	220MM	40MM
40 W	300MM	50MM



ESSENTIAL FLOODLIGHT



100-240Volts
50/60Hz

IP65

IK06

The LED Flood Light series offers a versatile and compact range of floodlights, designed with different output levels and boasting an impressive efficiency of up to 105 L/W. These flood lights are suitable for a wide array of applications, including wall-mounted installations around building facades. They are ideal for both classic flood lighting of buildings and illuminating outdoor areas.

In comparison to traditional flood lights, Honeywell LED Flood Lights provide immediate light without any startup or cooling-down times. With their robust aluminum housing and safety glass cover, these flood lights are specifically crafted for outdoor use, ensuring durability and reliability in various weather conditions.

APPLICATION AREAS



Public Areas



Industrial Areas



Car Park and Garage

FEATURES

- Illuminate with stunning efficiency, thanks to our products luminous efficacy of up to **105 lm/W**
- Experience enduring performance with an impressive lifetime of **30,000 hours (L70/B50)** with **3 years of warranty**
- Effortlessly customize your ambiance with two color temperature options: **3000K and 6500K**
- Enjoy reliable performance in demanding environments with robust IP65-rated protection against dust and water, along with IK06 impact resistance
- Operate seamlessly in temperatures ranging from **-20°C to +40°C** with our meticulously designed lighting
- Experience hassle-free compatibility with our lighting, supporting a wide nominal voltage range of **100-240V** and an operating frequency of **50/60Hz**
- Expanded Illumination: With a beam angle of **110 degrees**, our product can cover a larger area, eliminating dark spots and ensuring a well-lit environment
- Equipped with a robust **1 KV surge protection**, ensuring optimal safety for the electronic circuits inside during voltage spikes

TECHNICAL SPECIFICATIONS

MODEL NUMBER	ITEM DESCRIPTION	RATED POWER	RATED LUMENS	RATED CCT	RATED EFFICACY	BEAM ANGLE	CRI	DF
841930040102	Ess FL 30W 3000K 3150 100-240 V IP65 ND	30 W	3,150 LM	3000 K	105 LM/W	110 °	>80	>0.9
841965040122	Ess FL 30W 6500K 3150 100-240 V IP65 ND	30 W	3,150 LM	6500 K				
841930040132	Ess FL 50W 3000K 5250 100-240 V IP65 ND	50 W	5,250 LM	3000 K				
841965040152	Ess FL 50W 6500K 5250 100-240 V IP65 ND	50 W	5,250 LM	6500 K				
841930040162	Ess FL 70W 3000K 7350 100-240 V IP65 ND	70 W	7,350 LM	3000 K				
841965040182	Ess FL 70W 6500K 7350 100-240 V IP65 ND	70 W	7,350 LM	6500 K				
841930040012	Ess FL 100W 3000K 10500 100-240 V IP65 ND	100 W	10,500 LM	3000 K				
841965040032	Ess FL 100W 6500K 10500 100-240 V IP65 ND	100 W	10,500 LM	6500 K				
841930040042	Ess FL 150W 3000K 15750 100-240 V IP65 ND	150 W	15,750 LM	3000 K				
841965040062	Ess FL 150W 6500K 15750 100-240 V IP65 ND	150 W	15,750 LM	6500 K				
841930040072	Ess FL 195W 3000K 20475 100-240V IP65 ND	195 W	20475 LM	3000 K				
841965040092	Ess FL 195W 6500K 20475 100-240V IP65 ND	195 W	20475 LM	6500 K				

PRODUCT SIZE

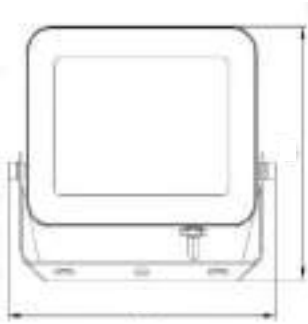

30W	50W	70W	100W	150W	195W
164*139*29MM	183*169*29MM	216*189*33MM	254*217*33MM	327*265*33MM	405*326*36MM

POLAR INTENSITY DIAGRAM

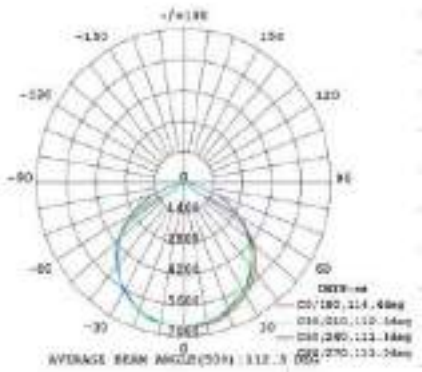

30
W

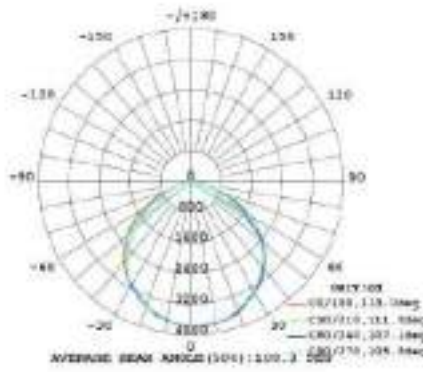

50
W

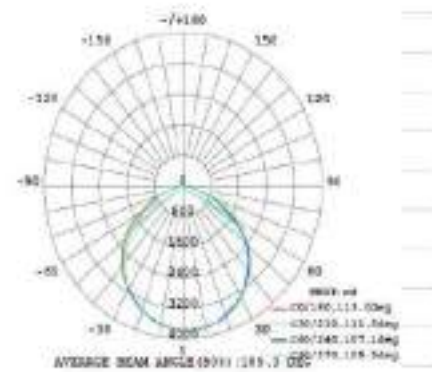

70
W

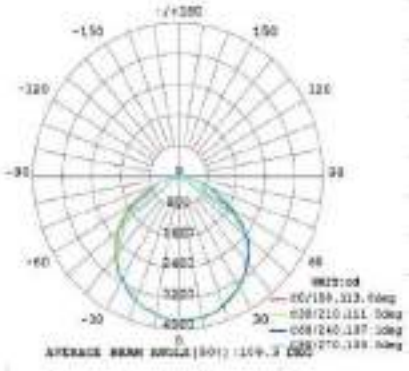

100
W

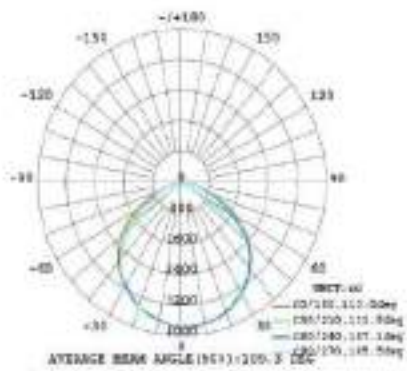

150
W

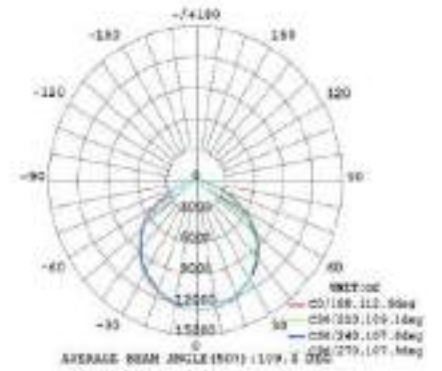

195
W



ESSENTIAL HIGH BAY



Introducing our Essential High Bay Range, a testament to robust industrial design tailored for illuminating facilities with high ceilings at heights of 5 meters or more. This cutting-edge solution serves as a seamless replacement for traditional high bay luminaires, providing unparalleled performance and convenience.

With an impressive lifespan of 30,000 hours, our high bay significantly reduces maintenance costs while prioritizing sustainability by eliminating the use of hazardous materials such as mercury.



100-240Volts
50/60Hz



IP65



IK06

APPLICATION AREAS

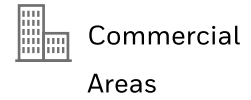
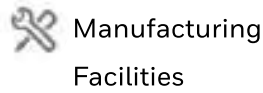

FEATURES

- Illuminate with stunning efficiency, thanks to our products luminous efficacy of up to **100 lm/W**
- Experience enduring performance with an impressive lifetime of **30,000 hours (L70/B50)** with **3 years of warranty**
- Effortlessly customize your ambiance with three color temperature options: **3000K, 4000K, and 6500K**
- Enjoy reliable performance in demanding environments with robust **IP65-rated** protection against dust and water, along with **IK06** resistance
- Operate seamlessly in temperatures ranging from **-20°C to +40°C** with our meticulously designed lighting
- Experience hassle-free compatibility with our lighting, supporting nominal voltage range of **100-240V** and an operating frequency of **50/60Hz**
- Equipped with a robust **2 KV surge protection**, ensuring optimal safety for your electronics during voltage spikes

TECHNICAL SPECIFICATIONS

MODEL NUMBER	ITEM DESCRIPTION	RATED POWER	RATED LUMENS	RATED CCT	RATED EFFICACY	BEAM ANGLE	CRI	DF
841930060232	Ess HB 80W 3000K 8400 100-240V F IP65 ND	80 W	8,400 LM	3000 K	105 LM/W	110 °	>80	>0.9
841940060242	Ess HB 80W 4000K 8400 100-240V F IP65 ND	80 W	8,400 LM	4000 K				
841965060252	Ess HB 80W 6500K 8400 100-240V F IP65 ND	80 W	8,400 LM	6500 K				
841930060262	Ess HB 100W 3000K 10500 100-240V F IP65 ND	100 W	10,500 LM	3000 K				
841940060272	Ess HB 100W 4000K 10500 100-240V F IP65 ND	100 W	10,500 LM	4000 K				
841965060282	Ess HB 100W 6500K 10500 100-240V F IP65 ND	100 W	10,500 LM	6500 K				
841930060292	Ess HB 150W 3000K 15750 100-240V F IP65 ND	150 W	15,750 LM	3000 K				
841940060302	Ess HB 150W 4000K 15750 100-240V F IP65 ND	150 W	15,750 LM	4000 K				
841965060312	Ess HB 150W 6500K 15750 100-240V F IP65 ND	150 W	15,750 LM	6500 K				
841930060322	Ess HB 195W 3000K 20475 100-240V F IP65 ND	195 W	20,475 LM	3000 K				
841940060332	Ess HB 195W 4000K 20475 100-240V F IP65 ND	195 W	20,475 LM	4000 K				
841965060342	Ess HB 195W 6500K 20475 100-240V F IP65 ND	195 W	20,475 LM	6500 K				

PRODUCT SIZE

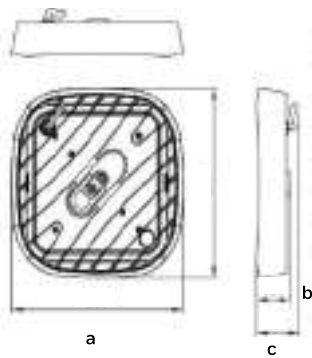

Essential High bay	80W	100W	150W	195W
a	230.4MM	230.4MM	273MM	326MM
b	44.4MM	44.4MM	47.4MM	51.3MM
c	57MM	57MM	60MM	64MM

POLAR INTENSITY DIAGRAM

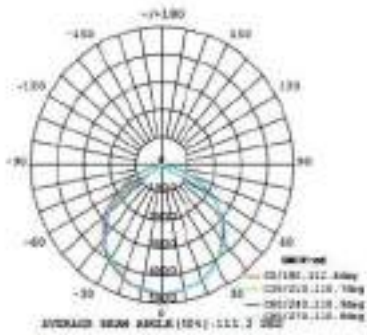

80 W

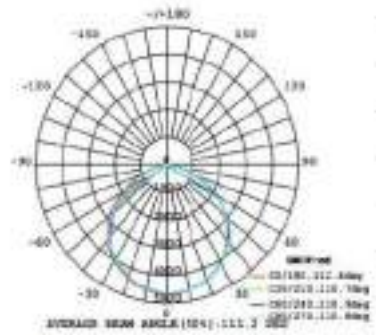

100 W

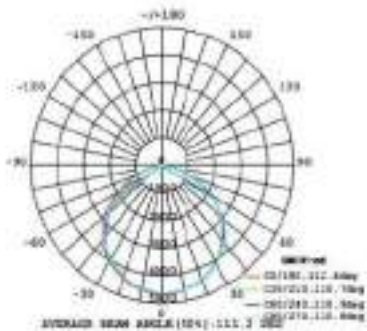

150 W

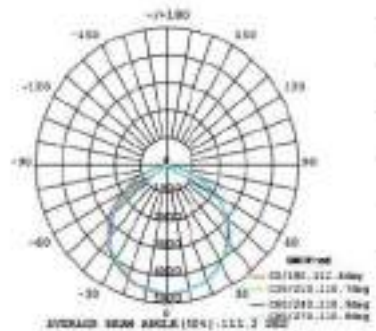

195 W



ESSENTIAL LED WEATHERPROOF



IP65



IK08

Venture into a new age of outdoor lighting with our Essential Weatherproof Luminaire collection. Boasting a design that encapsulates both functionality and aesthetics, this series ensures swift installation,

easily integrating into standard fixtures. Beyond its ease of setup, these luminaires are heralded for their remarkable energy efficiency when compared to traditional outdoor lighting.

APPLICATION AREAS



Residential Lighting



Commercial Lighting



Industrial Lighting

FEATURES

- Illuminate with stunning efficiency, thanks to our products luminous efficacy up to 130 LM/W
- Effortlessly customize your ambiance with two color temperature options: 4000K and 6500K
- Experience enduring performance with an impressive lifetime of 30,000 hours (L70/B50) with 3 years warranty
- Operate seamlessly in temperatures ranging from -20°C to +45°C with our meticulously designed lighting
- Provides uniform and even illumination across the entire surface, creating a comfortable and well-lit environment
- Built to withstand various weather conditions with robust IP65-rated protection against dust and water ensuring long-lasting performance without frequent replacements
- Instant start-up without any warm-up time, ensuring immediate and consistent illumination
- Flicker-free, ensuring a stable and comfortable lighting experience without any noticeable flickering or eye strain
- Engineered to operate safely, reducing potential risks associated with outdoor electrical fixtures

TECHNICAL SPECIFICATIONS

MODEL NUMBER	ITEM DESCRIPTION	RATED POWER	RATED LUMENS	RATED CCT	RATED EFFICACY	OPERATING VOLTAGE	CRI	DF
841940130012	Ess WP 18W 4000K 220-240V IP65 ND	18 W	2340 LM	4000 K	130 LM/W	220-240 V	RA>80	> 0.9
841965130022	Ess WP 18W 6500K 220-240V IP65 ND	18 W	2340 LM	6500 K				
841940130032	Ess WP 36W 4000K 220-240V IP65 ND	36 W	4680 LM	4000 K				
841965130042	Ess WP 36W 6500K 220-240V IP65 ND	36 W	4680 LM	6500 K				
841940130052	Ess WP 48W 4000K 220-240V IP65 ND	48 W	6240 LM	4000 K				
841965130062	Ess WP 48W 6500K 220-240V IP65 ND	48 W	6240 LM	6500 K				

POLAR INTENSITY DIAGRAM

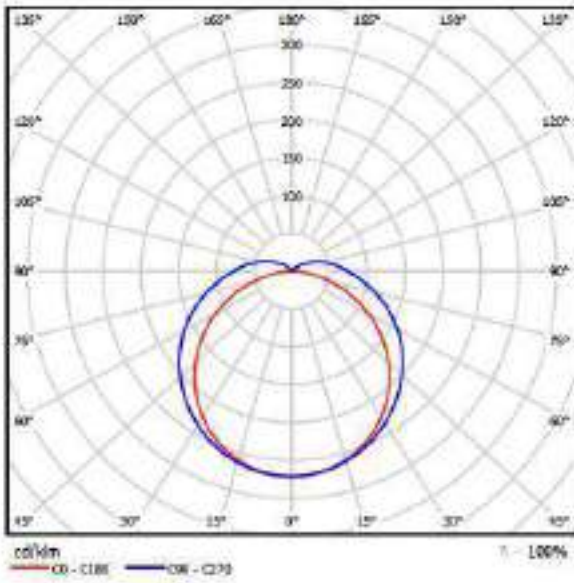

18W

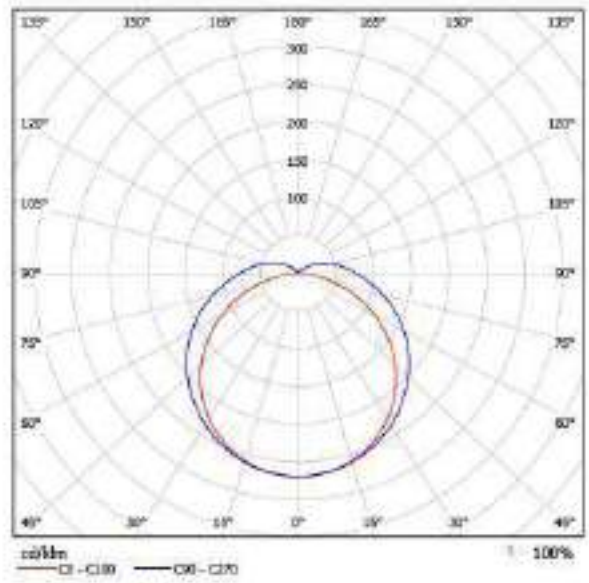

36W

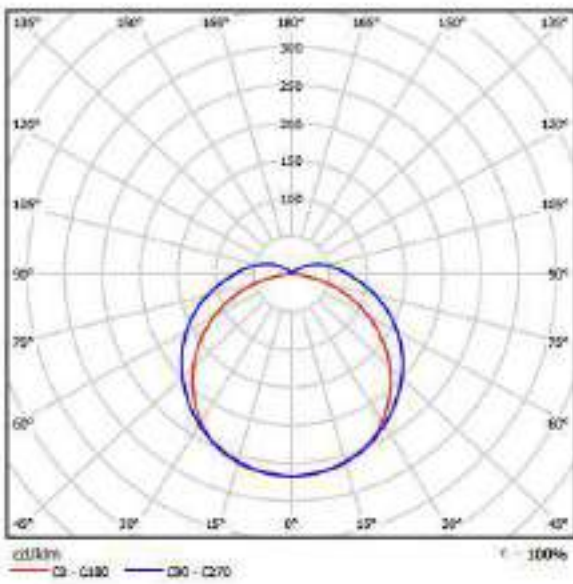

48W

PRODUCT SIZE

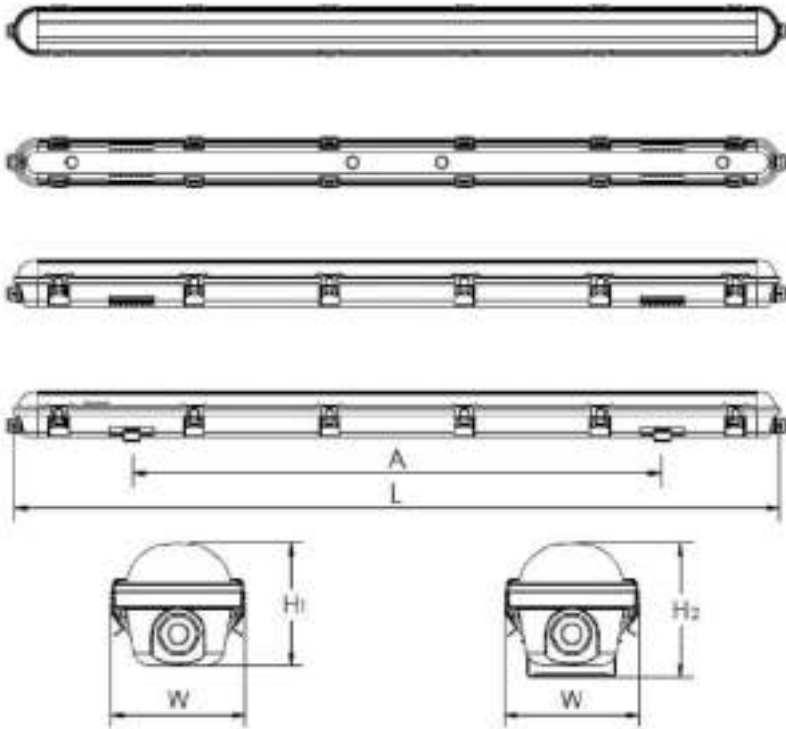

ESSENTIAL LED WEATHERPROOF	18W	36W	48W
L	600MM	1200MM	1500MM
W	78MM	78MM	78MM
H1	72MM	72MM	72MM
H2	82MM	82MM	82MM
A	290+40MM	830+40MM	1090+40MM



ESSENTIAL WEATHERPROOF HOUSING



IP65



IK08

Venture into a new age of outdoor lighting with our Essential Weatherproof Housing collection. Supplemented to our integrated LED weatherproof fixtures,

this series ensures swift installation, easily combines with our LED T8 tubes to offer an LED retrofit solution for traditional outdoor weatherproof fixtures.

APPLICATION AREAS



Residential Lighting



Commercial Lighting



Industrial Lighting

FEATURES

- Built to withstand various weather conditions with robust IP65-rated protection against dust and water ensuring long-lasting performance without frequent replacements.
- Choice of two versions which can work with single-ended or double-ended LED T8 tubes
- Anti-corrosion stainless steel clips ensure durability of the fixtures
- Built-in metal tray to improve structural strength and lumen efficacy.
- Full PC body provides IK08 impact resistance
- Available in 2ft, 4ft, 5ft lengths, and single lamps, twin lamps designs

TECHNICAL SPECIFICATIONS

MODEL NUMBER	ITEM DESCRIPTION	CONNECTION	TUBES	LENGTH
84190013013	Essential Weatherproof Housing Single Ended Twin Tube 600MM	Single Ended	Twin Tube	600MM
84190013014	Essential Weatherproof Housing Single Ended Twin Tube 1200MM	Single Ended	Twin Tube	1200MM
84190013015	Essential Weatherproof Housing Single Ended Twin Tube 1500MM	Single Ended	Twin Tube	1500MM
84190013016	Essential Weatherproof Housing Double Ended Twin Tube 600MM	Double Ended	Twin Tube	600MM
84190013017	Essential Weatherproof Housing Double Ended Twin Tube 1200MM	Double Ended	Twin Tube	1200MM
84190013018	Essential Weatherproof Housing Double Ended Twin Tube 1500MM	Double Ended	Twin Tube	1500MM
84190013019	Essential Weatherproof Housing Single Ended Single Tube 600MM	Single Ended	Single Tube	600MM
84190013020	Essential Weatherproof Housing Single Ended Single Tube 1200MM	Single Ended	Single Tube	1200MM
84190013021	Essential Weatherproof Housing Single Ended Single Tube 1500MM	Single Ended	Single Tube	1500MM
84190013022	Essential Weatherproof Housing Double Ended Single Tube 600MM	Double Ended	Single Tube	600MM
84190013023	Essential Weatherproof Housing Double Ended Single Tube 1200MM	Double Ended	Single Tube	1200MM
84190013024	Essential Weatherproof Housing Double Ended Single Tube 1500MM	Double Ended	Single Tube	1500MM

Note: Check with your local sales organization for ordering codes

PRODUCT SIZE

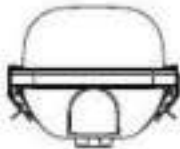
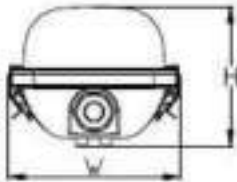
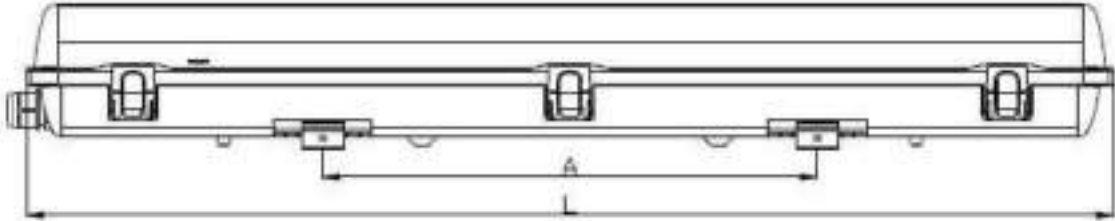

ESSENTIAL WEATHERPROOF HOUSING	2FT SINGLE TUBE	4FT SINGLE TUBE	5FT SINGLE TUBE	2FT TWIN TUBE	4FT TWIN TUBE	5FT TWIN TUBE
L	660MM	1269MM	1569MM	660MM	1269MM	1569MM
W	78MM	78MM	78MM	104MM	104MM	104MM
H	87MM	87MM	87MM	87MM	87MM	87MM
A	265-335MM	745-815MM	1045-1115MM	265-335MM	745-815MM	1045-1115MM

VESRA MEA FZ - LLC

1907, Opal Tower, Business Bay, Dubai, UAE
Website: honeywell-lighting.com
Email: support@honeywell-lighting.com
Phone: +971 800 83 772

The Honeywell trademark is used under license
from Honeywell International Inc. This product
is manufactured by VESRA MEA FZ LLC

Honeywell